

# SD21

## Speed over ground (SOG) Speed log with inbuilt STW sensor

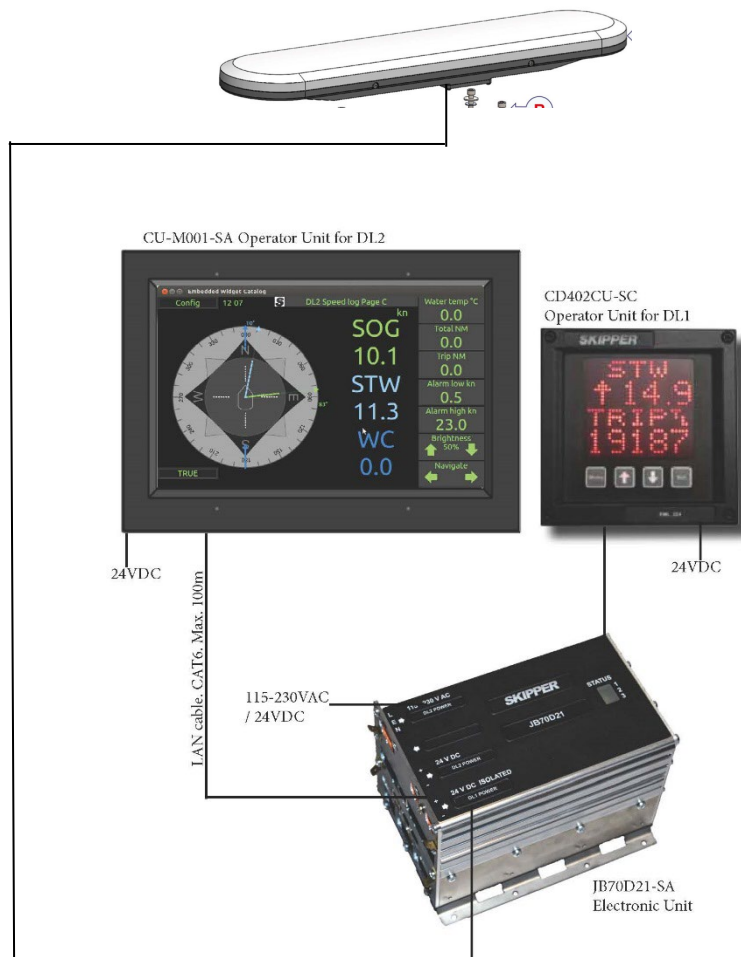

Part Number: DM-M009-SA rev 1812  
preliminary  
Date: 06.02.2017  
For Softwares up to SW-M013-1.0.0

- Table of abbreviations..... 3
- Introduction and Specification ..... 4
- Installation..... 6
  - Antenna centres ..... 6
  - Antenna locations..... 7
  - Masking ..... 7
  - Interference from other radiating sources..... 9
  - Mounting the antenna unit ..... 10
  - Installation of the JB70 Electronic unit..... 14
  - Installation of the screen..... 16
  - Software setup ..... 18
  - Display setup ..... 20
  - System Setup..... 22
  - JB70 Setup ..... 23
  - Aux setup..... 24
- USER Information ..... 26
  - Introduction..... 26
  - Presentation ..... 26
  - Screen Configuration..... 26
  - Changing the look of the screen..... 28
  - Errors ..... 28

## Table of abbreviations

Symbol/abbreviation	Explanation
THD	Transmitting heading device
GNSS	
GPS	Global Positioning System
GLONASS	Positioning system
SOG	Speed over ground
ROT	Rate of turn
HDG	Heading
SOGL	Longitudinal (alongships) Speed over ground
SOGT	Transversal (Athwartships) Speed over ground
CCRP	Picture speed. The amount of time presented on the screen
Kn	Knots
m/s	Speed in meters / second
mi/h	Miles per hour
M	Meters
Min	Minutes
V	Volts
DC	Direct Current (for voltage)
CAM	Central alarm management
INS	Integrated navigation system
LAN	Local area network
SFI	System function identifier, from standard IEC61192-450
UDP	Data sent on the LAN ports
MAC	Unique system identifier for LAN system
IP	Internet protocol address, unique in the network

## Introduction and Specification

The SKIPPER SD21 is the first of a new generation of Satellite based Speed logs from SKIPPER. It is made to fulfill the basic ISO/IMO standards, as well as the modern IEC standards for maritime equipment and alarm handling.

Features include:

- Easy and logical operation via a touch display
- Flexible installation with minimal wiring
- Basic but comprehensive communication and features

The system uses a Dual satellite antenna capable of receiving both GPS and GLONAS and from these signals can calculate speed over ground, the heading, and using an internal sensor, Rate of Turn.

The system is designed as part of the MULTI family of products, and shares a user interface with the other multi products, The SD21 includes a SKIPPER DL1-Multi system to provide an independent but integrated Speed Through Water sensor. The DL1 Multi part of the system has its own manual. As connection and interface is independent of the SATLOG SOG functions.

The Results of the DL1 are internally linked to the SATLOG system so that values from both systems can be displayed on the graphic screen, and fed from the NMEA VBW sentence of the SATLOG system. This allows a single repeater to be used for both parameters.

The DL1 is, however, an independent system, and if the vessel has a requirement for separate STW and SOG sensors, then the DL1 (STW) must be connected directly to the navigation systems, and not via the SOG system.

## Specification:

IP	Value	Unit
Antenna	GPS, GLONASS position GNSS speed Transmitting Heading Device (THD) Dimension H: 100mm, W: 180mm, L: 780mm Weight 3kg excluding bracket Operational Temperature -25 to 55 deg C Storage Temperature -30 to 70 deg C IP Grade IP66 The antenna will interface with peripheral systems and sensors using standard and/or proprietary datagram formats. GNSS type NV08C-CSM GPS L1 : 1575.42 MHz GLONASS L1: 1602.0MHz for Fk=0 where k= (-7 to +13) channel spacing 562.5kHz Compass safe distance 0.3m	
Electrical parameters CU-M001-SB Control Unit JB70SD2-SA Electronic unit SATLOG Antenna	Nominal 24VDC ( Max 4W) 21VDC to 36VDC Compass safe distance:1.2m 110V-230VAC or 24VDC (21-36V) Compass safe distance: 1.4m 12-24VDC <5W Compass safe distance:0.3m	
Connections CU-M001-SB Control unit JB70SD21-sa Electronic unit	WAGO spring connector (12 pins)/ RJ45 WAGO spring connector (12/24 pins)/ RJ45 / 2/3 pin power connectors	
Outputs from control unit J1	None	
Inputs to control unit J1	2 NMEA (IEC61162-1) Accepting signals from Dimmer DDC.	
LAN	1 port RJ45 (IEC61162-450)	
Outputs from the JB70SD21 unit (SATLOG part)	4 x NMEA (IEC61162-1) 2 x LAN (IEC61162-450)	
Auxilliary outputs	2 optoisolated ports giving Pulses/NM , speed limits, power failure, static on and static off, fitness 1 Relay output for all except Pulses/NM	
Auxiliary input	1 used for alarm reset	
Alarms	No alarms in use.	
Functions	Vector Speed, Longitudinal, transversal Resultant speed Aft Transversal speed Distance travelled (over ground) Interface to SKIPPER speed through water log <ul style="list-style-type: none"> <li>- EML</li> <li>- DL1</li> <li>- DL2</li> </ul>	

Secondary functions (Cannot be used as primary source)	Position Heading ROT	
--	----------------------------	--

## Installation

### Antenna

Sensor unit location Consider these factors when installing the antenna unit.

- Keep the space above the antenna unit free of obstructions of any kind.
- Mount the antenna unit in such a way that the GNSS signal is not blocked.
- Protect the sensor unit from direct illumination of radar beams and other transmitting antennas such as Inmarsat antennas. SL-SN300 antenna is more sensitive to blocking and reflections (multipath) of GNSS signals than GNSS sensors, which only use pseudo-range data. This is because SL-SN300 antenna also uses carrier phase measurements for heading determination, and both internal GNSS antennas need to see at least four common satellites at the same time.
- Mount the sensor unit above the nearest deck at a height which is equal to the width of this deck or higher in order to reduce problems due to multipath effects.
- Mount the sensor unit in such a way what torsion movement relative to the ship's hull is kept at an absolute minimum.
- Mount the sensor unit alongship with the bow arrow pointing forward and horizontally. The maximum allowed deviation angle from the alongship axis and horizontal plane is  $\pm 5$  degrees. Otherwise the heading accuracy will be degraded.

### Antenna centres

At the bottom of the sensor unit the centres for the two GNSS antennas are indicated with a raised point on each side of the unit. These are the measurement points from which the position is calculated.

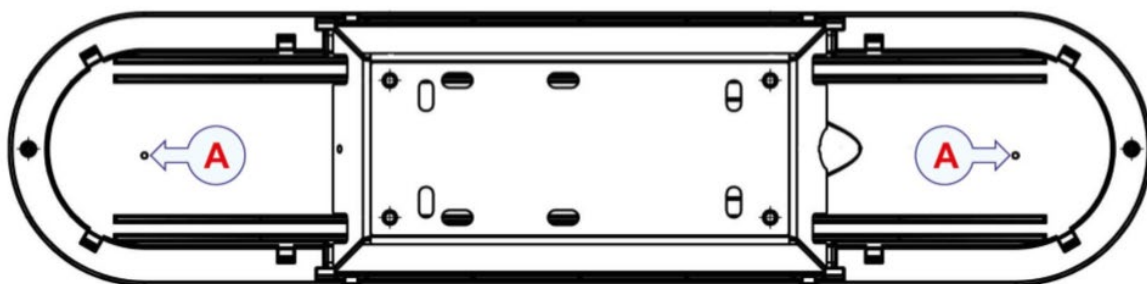

**A** Antenna centres

### Installation

Installing GNSS and DGNSS antennas, recommended practice GNSS and DGNSS antennas are critical for operation and their location on the vessel must have high priority. Antenna location, separation

and cable quality should be considered, as incorrect or inadequate installation can lead to poor positioning performance or complete loss of position. If the antenna is installed in a poor location, it can suffer from masking, multipath or interference from other radio sources which can affect the position performance.

Antenna location and separation GNSS and DGNSS antennas should be separated both horizontally and vertically to reduce the risk of in-band interference, lightning strike and mechanical damage. If space is limited, DGNSS antennas should get the better location. Antenna separation can be problematic for vessels with limited space in the main mast. A possible solution can be to locate GNSS/DGNSS antennas on the port and starboard sides of the instrument mast. For drilling units the top of the derrick is also a possible location for GNSS/DGNSS antennas. A general antenna arrangement including satellite communication is illustrated.

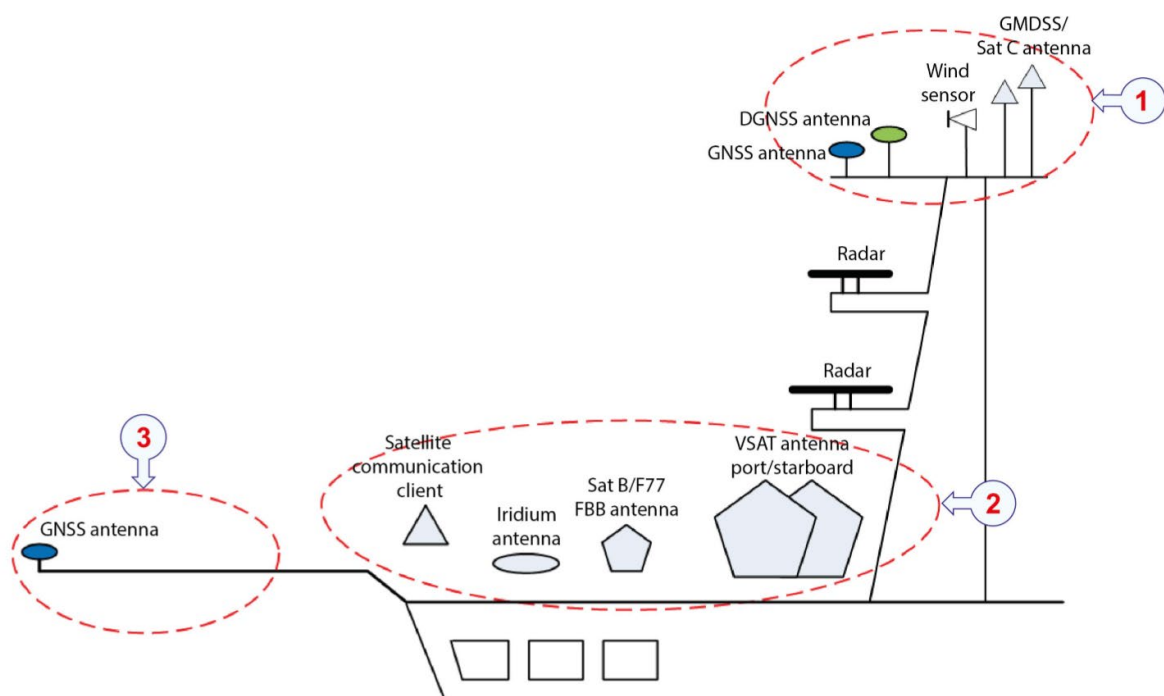

## Antenna locations

- 1** Protected area
- 2** Open area (risk of interference)
- 3** Helideck

## Masking

The GNSS antenna should have an unobstructed line of sight to the sky. The signals from the satellite propagate by line-of-sight, which means that if the antenna cannot see the satellite, the reception will be severely impaired, if it occurs at all. Potential obstructions are other masts and antennas, cranes, rigs and fixed platforms, buildings in ports, high cliffs or hills close to shore. The impact of this can be anything from degraded performance to a complete loss of positioning.

Crowded mast



Good antenna location



Multipath Inappropriate location of the antenna can result in the antenna receiving reflections of the incoming signal as well as the signal itself (multipath). The reflected multipath signal takes a longer path than the direct signal, introducing an error into the position calculation.



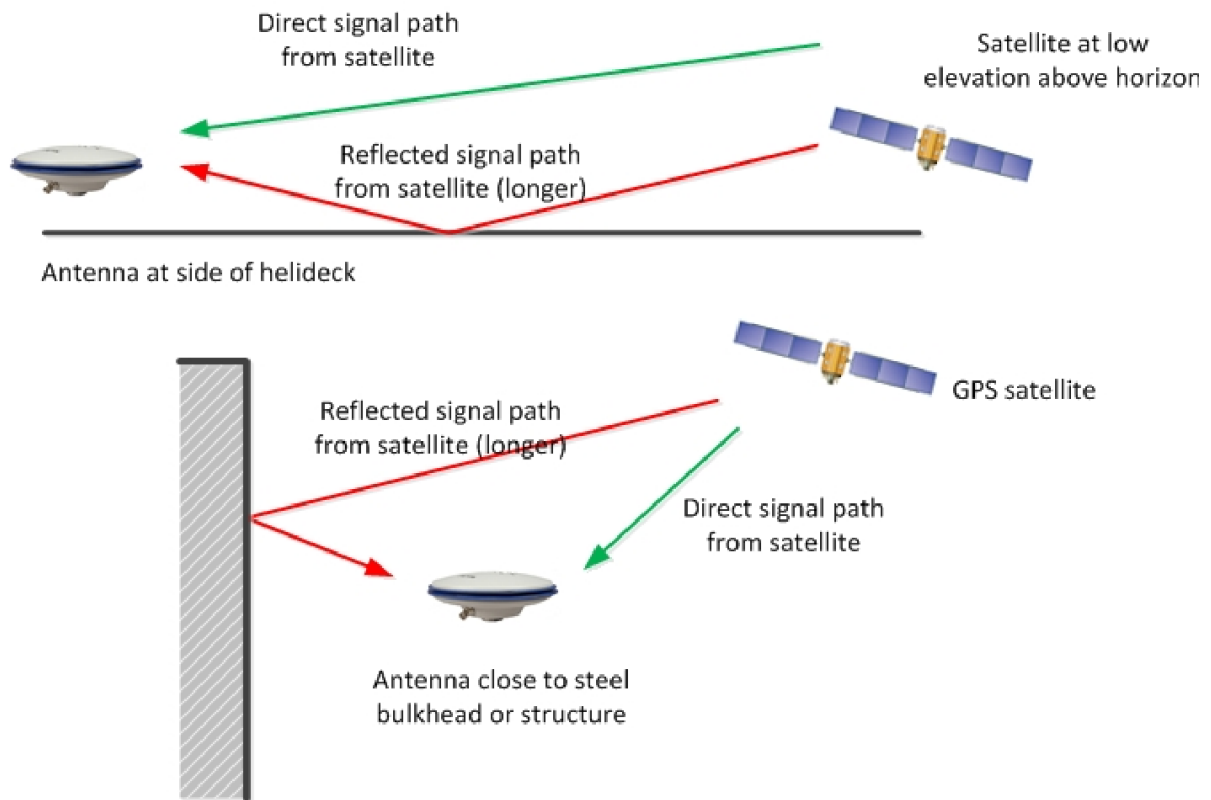

### Interference from other radiating sources

Interference can be caused by close proximity to other radiating sources. Installing GNSS antennas in close proximity to satellite communication systems operating in or nearby GPS/GLONASS frequency bands (1.2 to 1.6GHz) should be avoided (i.e. SatC, Iridium). Ideally the antenna should be situated at a minimum of 3 metres from other radiating sources. As this is not always practically possible, a compromise location must be sought. A typical antenna distribution is illustrated.

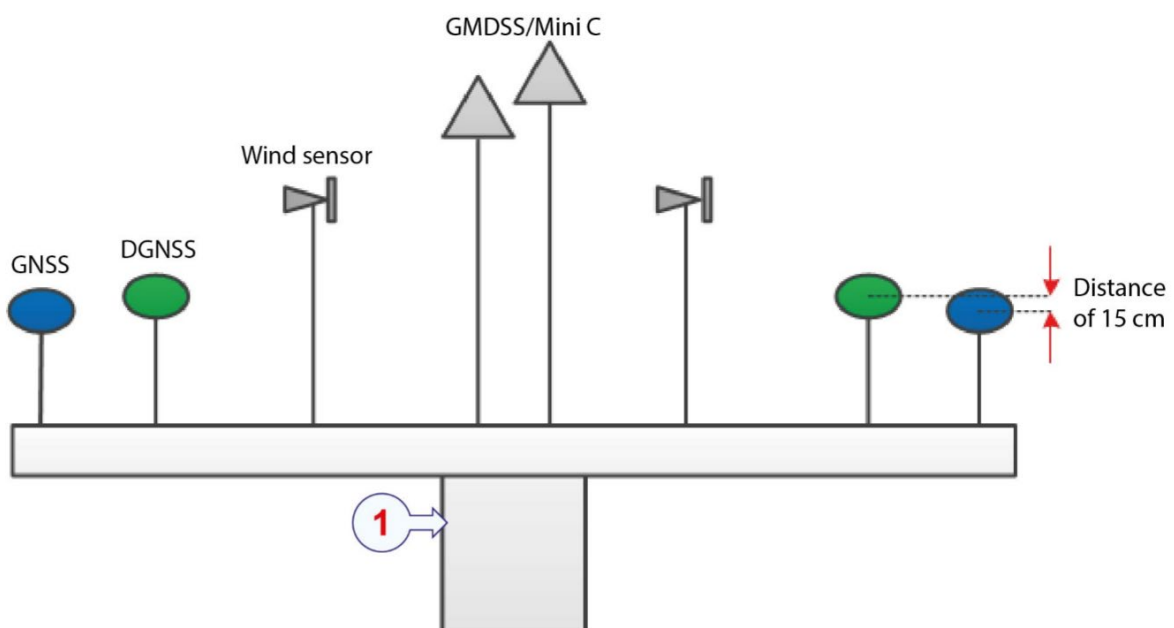

## 1 Radar mast/instrument mast

GNSS/DGNSS antennas must not be placed within the Mini C antenna beam (15 degrees below the Mini C antenna's horizontal plane). The vertical separation should be at least 1.5 metres.

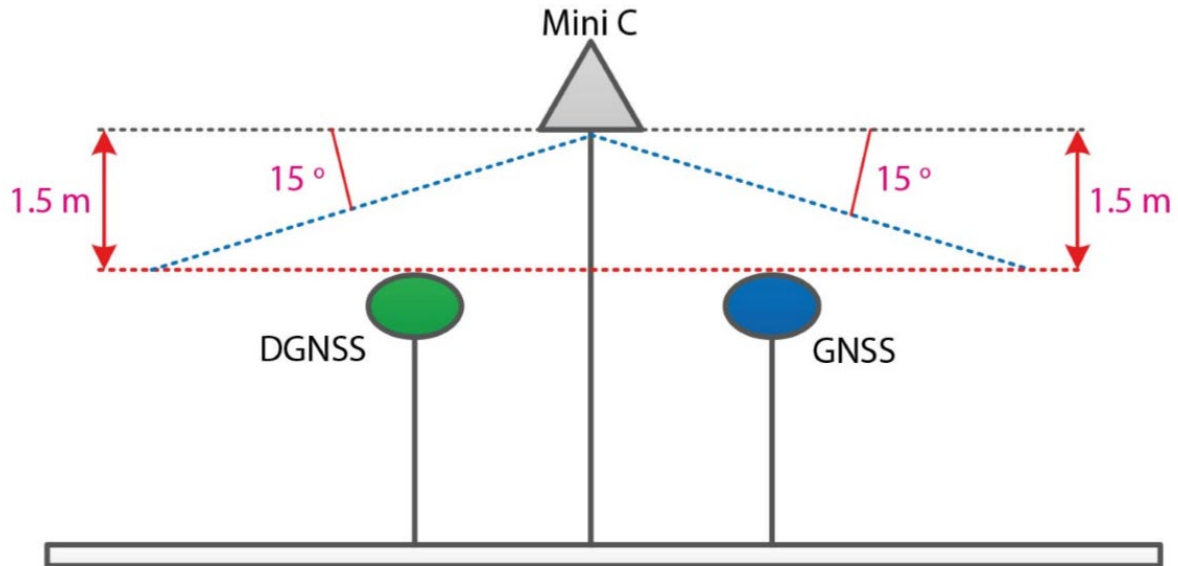

During installation, comprehensive tests should be carried out for potential interference by conducting transmissions from each RF source for extended periods, individually and simultaneously.

## Mounting the antenna unit

The sensor unit is designed to be mounted horizontally on a roof, railing or similar.

### Prerequisites

Use U-bolts to mount the sensor unit mounting bracket to a rail. Or prepare a suitable mounting arrangement for surface mounting of the bracket. Use the mounting bracket as a template to drill holes for the bolts. U-bolts for sensor unit mounting are not delivered by SKIPPER Electronics AS. Install and terminate the cable before you mount the sensor unit. A wiring diagram is located inside the lid of the termination box underneath the sensor unit.

### Cable specifications for the sensor unit cable.

- 2-5 pair, Shielded Twisted Pair (STP)
  - 2 tsp for basic use pin 1,9,5,13 (for normal use)
  - 2 tsp for LAN interface in JB70SD21 (recommended for ease of antenna upgrade)

Water proof, 3 pair, 4 pair, 8 pair cable can be supplied by SKIPPER on request

### Cable Specification:

- Minimum 0.5 mm<sup>2</sup> power wire, 0.25 mm<sup>2</sup> data wire

- Maximum 1.5 mm<sup>2</sup> wires
- Outer cable dimensions 10 to 14 mm

The wiring for the sensor unit cable.

PIN	Signal	Description	Pin	Signal	Description
1	0V	Power ground	9	12-24VDC	Power +
2	RJ3 RXD+	RX- Ethernet Only needed for upgrade	10	RJ6 RXD-	RX- Ethernet Only needed for upgrade
3	RJ1 TXD+	TX- Ethernet Only needed for upgrade	11	RJ2 TXD-	TX- Ethernet Only needed for upgrade
4	RXA-	DGNSS corrections: RTCM 104 v. 2.3 (not used)	12	RXB-	DGNSS corrections: RTCM 104 v. 2.3 (Not used)
5	TXA-	RS-422 TX-	13	TXB+	RS-422 TX+
6	Not used		14	GND	
7	Not used		15	Not used	
8	Not used		16	Not used	

Note ForRS422 ports, RX/TX-correspond to signal line RX/TXA, and RX/TX+ correspond to RX/TX B.

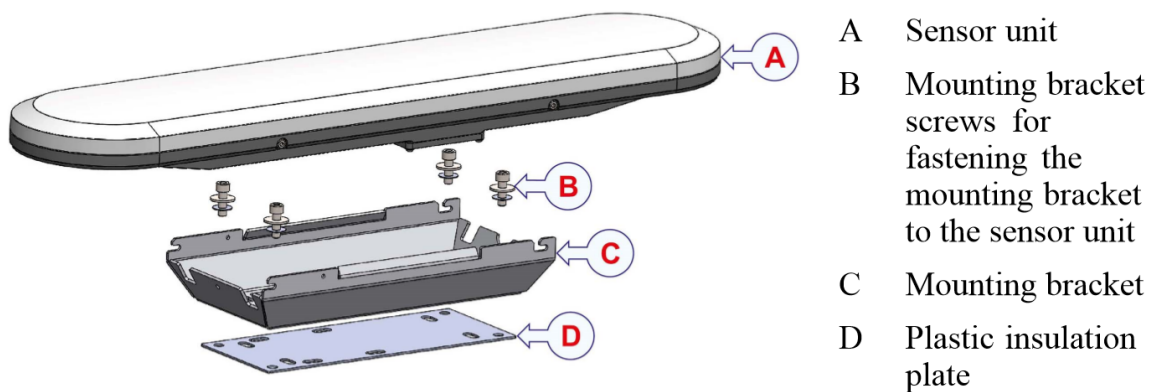

### Procedure

1. Separate the sensor unit from its mounting bracket by loosening the two screws on each side and removing the mounting bracket.

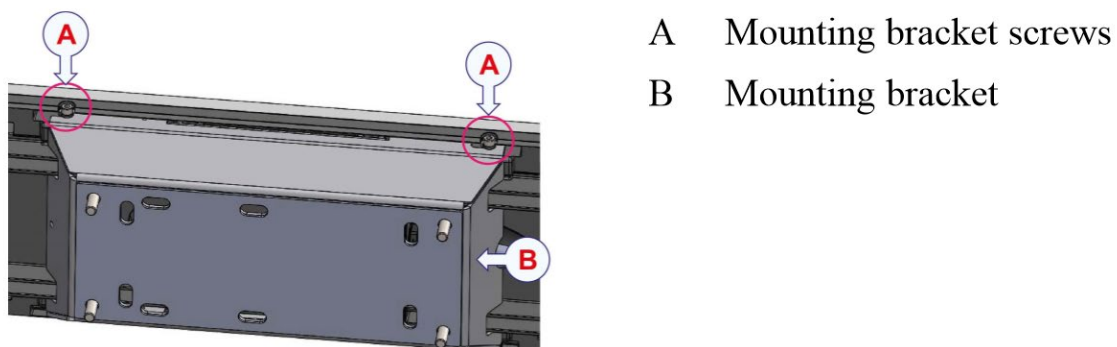

2. Place the plastic insulation plate underneath the mounting bracket to prevent corrosion.
3. Fasten the mounting bracket using the U-bolts or another mounting arrangement, such as a pre-prepared mounting bracket holder. Use plastic washers to prevent corrosion.

Observe the mounting direction of the mounting bracket. The groove for the cable should point in the aft direction of the vessel.

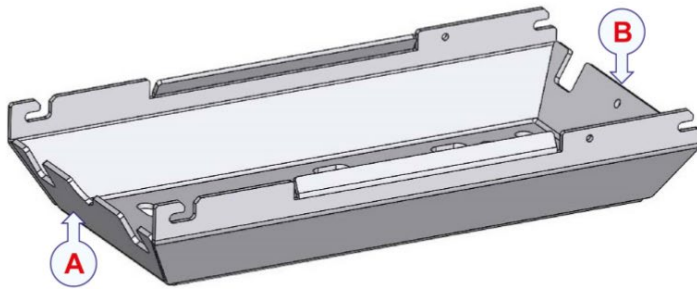

- A Aft direction
- B Bow direction

4. Lift the sensor unit onto the mounting bracket and refasten the four screws to attach the sensor unit to the mounting bracket.



- A Bow direction
- B Aft direction

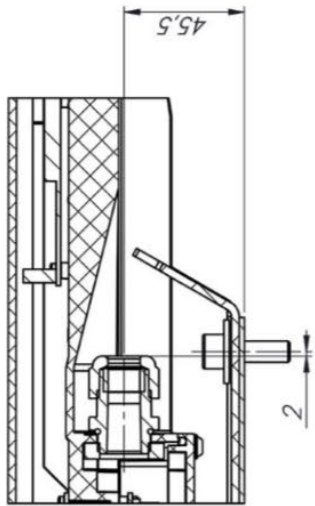

SECTION A-A  
SCALE 1 : 2

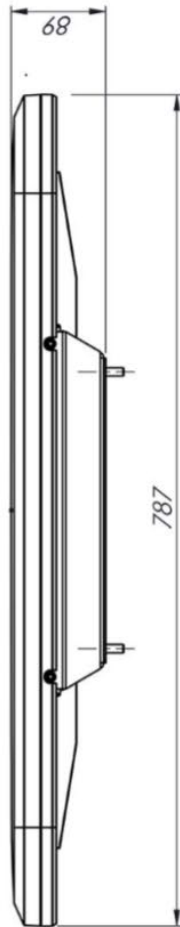
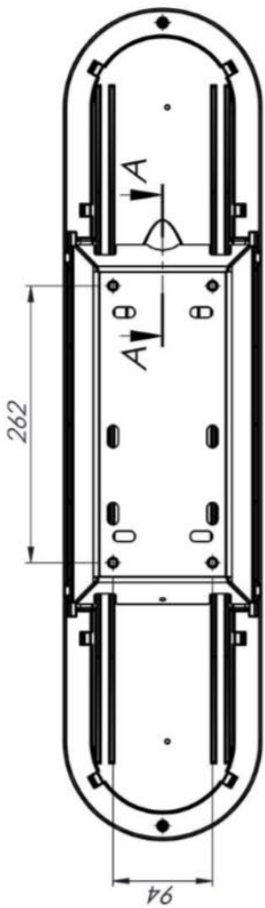
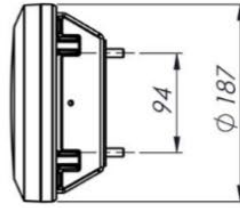

- Materials:
- Glass filled polyamide (PAGF) bottom part.
  - Acrylonitrile Styrene Acrylate (ASA) cover.
  - Aluminium bracket.
- Weight: 3,4 kg

## Installation of the JB70 Electronic unit.

The JB70 unit contains 2 independent systems and these are connected as follows.

The JB70SD21-XA does not contain a physical switch (only software) and should be connected to a circuit breaker for removal of power.

The SATLOG is powered from nominal 24VDC (Max 32VDC) and/or 115-220VAC.

The DL1 is powered from 24VDC Isolated input.

For wiring of DL1 Operator unit (CD402) please see "Installation manual DL1" DM-M002.

For wiring of SATLOG Operator unit (CU-M001) please see this manual

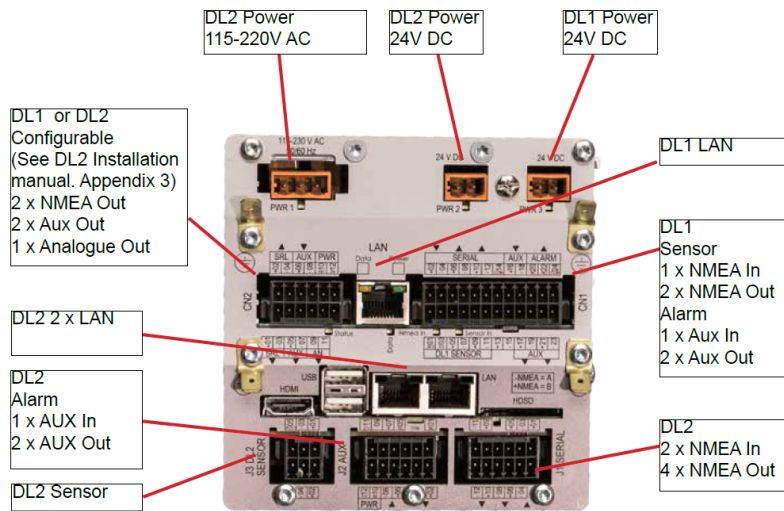
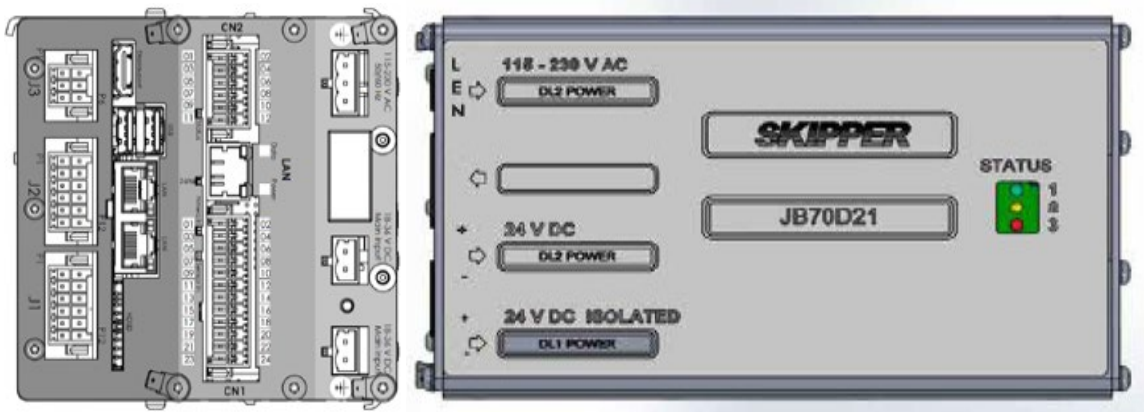

Connecting the sensor. The sensor requires a single NMEA style input and 24VDC Power line These can be found on the Sensor Connector J3. In addition a LAN plug can be connected to the antenna for upgrades.

This should be connected as follows:

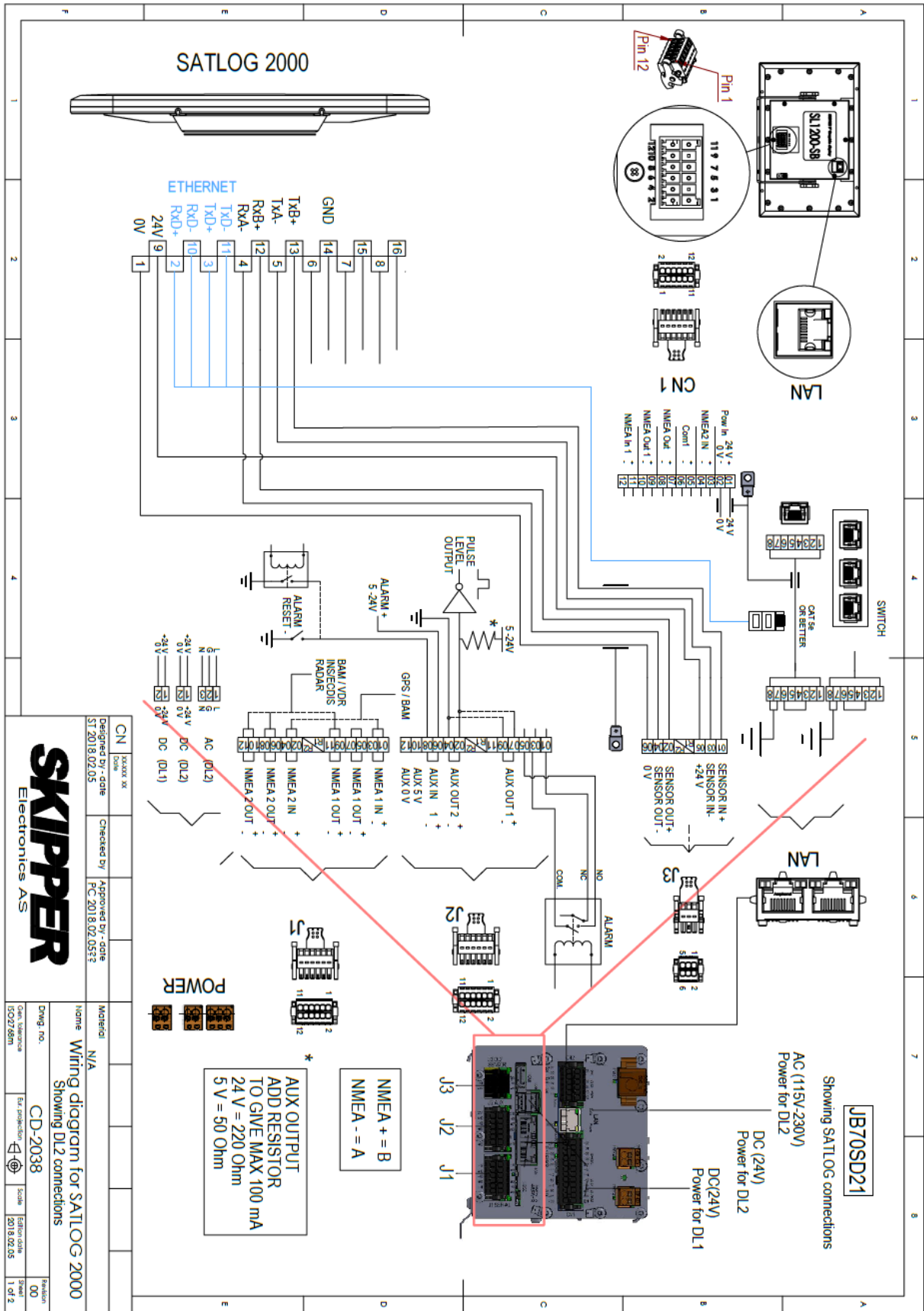



Pin	Function	Pin on antenna
1	TX+(optional if GNSS corrections to be used)	12
2	RX+	13
3	TX- (optional if GNSS corrections to be used)	4
4	RX-	5
5	+24V power to antenna	9
6	0V power to antenna	1

#### Optional LAN plug

	Pin in RJ45	Function	Pin on Antenna
	1 (green)	RX- Ethernet	10
	3 (white(green))	RX+ Ethernet	2
	2 (orange)	TX- Ethernet	11
	1 (white(orange))	TX+ Ethernet	3

This plug is only needed when antenna upgrade is required and can be disconnected otherwise.

SD21-SB Control unit: This display uses LAN (RJ45) connector to communicate with the JB70 unit.

### Installation of the screen

Connector	Function	Cable connected to	Min Recommended cable type
J1-1 DC 12-24 +	DC power supply	DC supply or JB40POW	0.25 mm2
J1-2 DC 0V -		DC supply or JB40POW	0.25 mm2
RJ45	Coms to bridge and electronic unit	RJ45 on JB70SD21-SA	CAT6 <100m



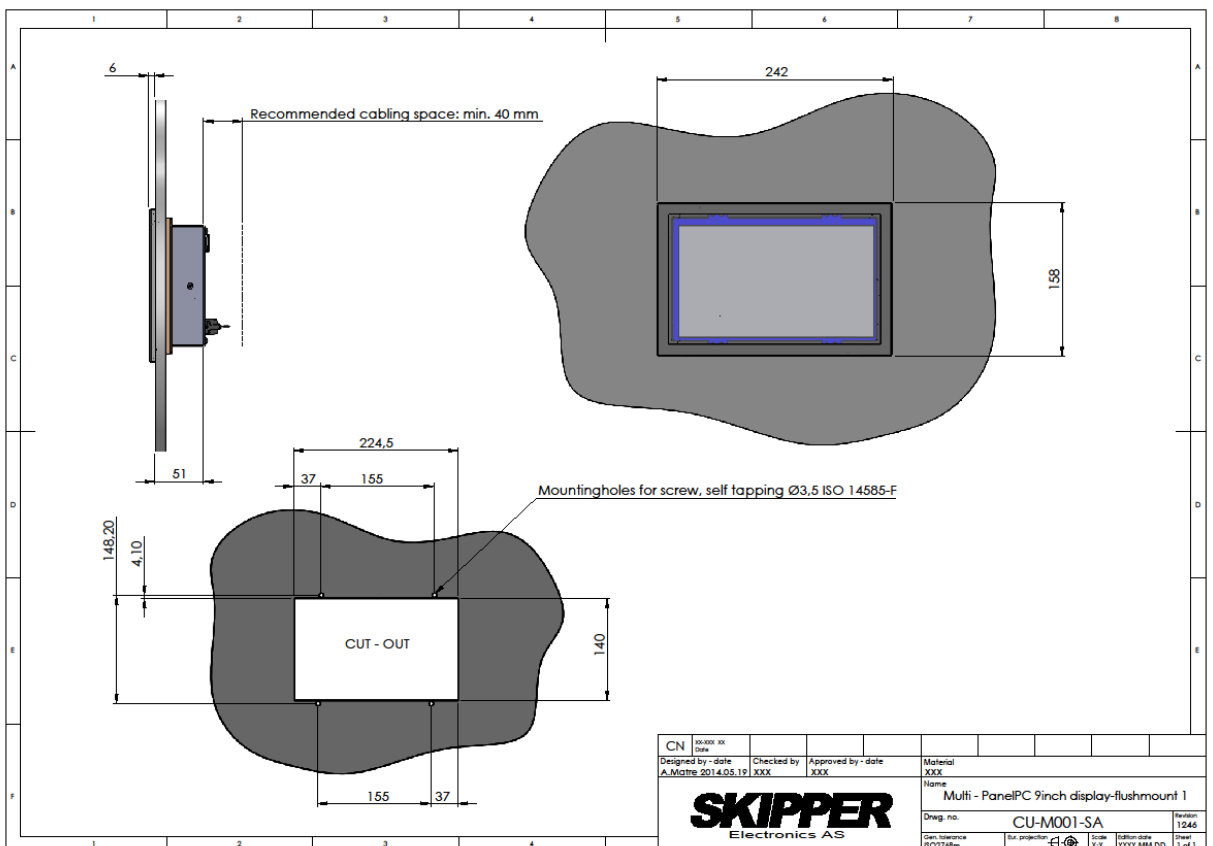
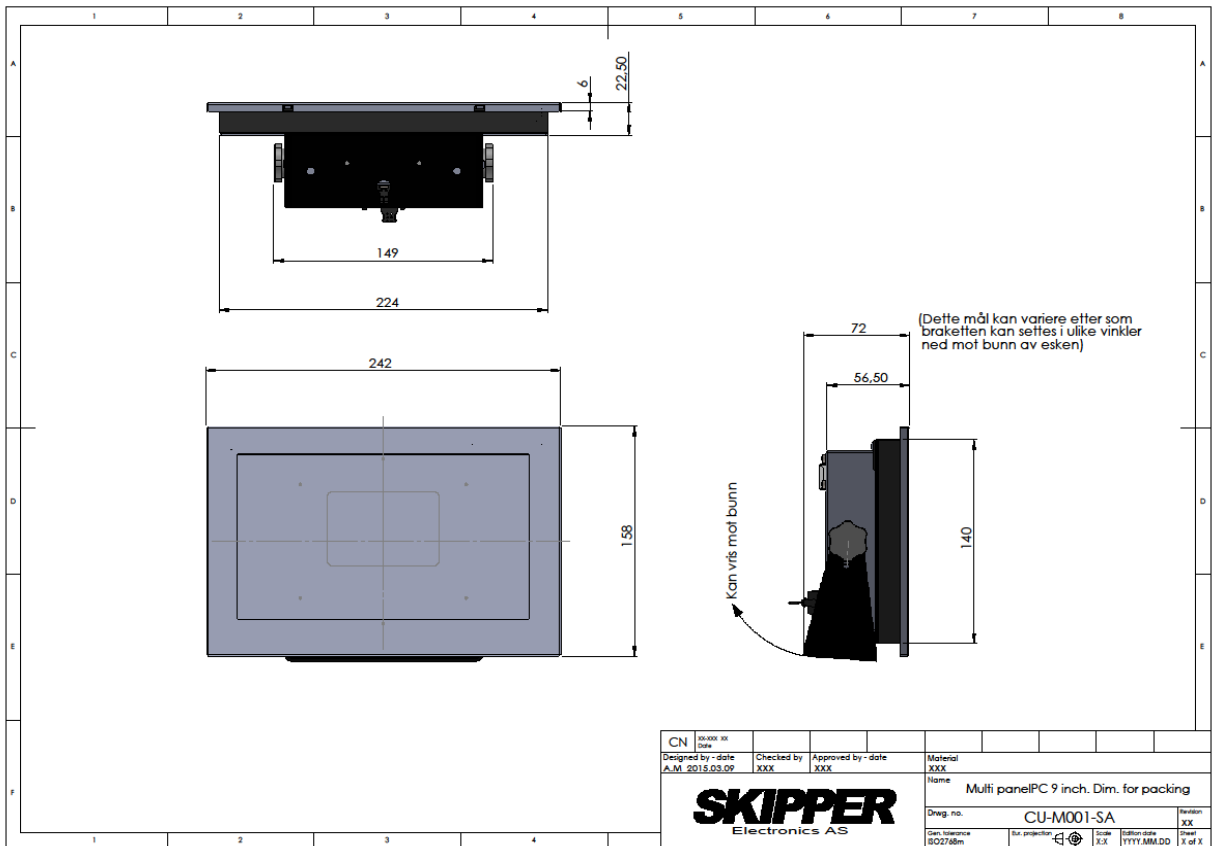

The screen can be mounted on consoles on overheads, or stand alone with optional mounting bracket part number MG-0002.

## Software setup

The software has 3 user runtime screens that can be configured as the user wishes. Set up of the system is simple, the only adjustments to be made is to adjust for mounting angular offset of the antenna.

## Calibration Setup

Once the system is turned on (Cold start), the antenna will need up to 15 minutes to get an accurate map of the available satellites. Once this is in place, the display will show speed in 3 axes. This is the approved usage of the system. In addition the system can give out heading ROT and position based on the antenna data.

Heading may show an error due to mounting, and this can be rotated to match the ships GYRO compass (True heading)

This is done in config-Calibration. The presentation shows the antenna heading and the heading with offset.

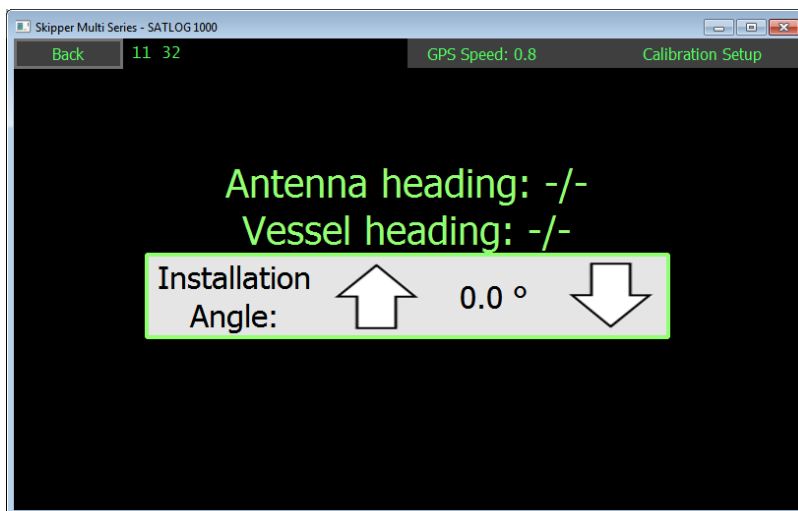

## Setup of Communications

The System has an internal RS485(isolated) communication to the antenna. To the outside world it has NMEA (IEC61162-1), Inputs (2) and output (2), also LAN (IEC61192-450) Port

## Outputs

The communications menu allows the NMEA messages to be selected for the output, on this system there 2 NMEA outputs, and a LAN output. All can be adjusted. Default is VBW output.

1. Output for NMEA IEC61162-1
2. LAN input and output for IEC61162-450 messages

This port can provide communication both by TCP/IP V4.0 or using IEC61162-450. If being used it requires a network that does not exceed 20Mbits/second. The system will exert/receive a maximum load of 40 datagrams/second

Config – Communications screen	
	<p>The selected channel (NMEA 1 or UDP)</p>
<p>The left side show a terminal emulator that shows the input or output messages of the selected channel. Pressing 'Message headers' will show the full message.</p>	<p>The Baud rate output (4800, 32400 or 115200)</p> <ul style="list-style-type: none"> <li>• VLW: Distance travelled over ground .</li> <li>• VTG: Actual course and speed relative to the ground.</li> <li>• VBW: Dual ground/Water speed. (STW information will also be provided)</li> <li>• DDC Dimming command output</li> </ul>
<p>Position and time signals</p> <ul style="list-style-type: none"> <li>• GGA*: Time, position and fix related data.</li> <li>• GLL*:Longitude and latitude of vessel position, time of position fix and status.</li> </ul> <p>*This system is speed log and cannot be used as primary source of other types of information. **only available on the LAN output</p>	<p>GPS Gyro and status</p> <ul style="list-style-type: none"> <li>• HDT*: Actual vessel heading in degrees True produced by any device or system producing true heading.</li> <li>• ROT*: Rate of turn and direction of turn.</li> <li>• THS*: Actual vessel heading in degrees True produced by any device or system producing true heading.</li> <li>• GSA**: Satellite DOP and active satellites.</li> <li>• GSV**:Numberofsatellitesinview,satelliteID,elevation,azimuthandSNR.</li> </ul>

Exact formats for these sentences can be found in the relevant IEC standards.

### Accepted inputs

Format	Function
\$__DDC,X,yy,X,C*nn	Dimming function X= O,N,K,D , YY is % the system will accept X and adjust to the user set level (See dimming)
Internal UDP	The System can also take information from other SKIPPER devices within the same network for display on screen or for logging

The Communications on NMEA are 4800, 8 data bits, 1 stop bit. Baud rate can be changed to 32400 or 115200

### Display adjustment

The display is very flexible and can be made to show exactly what the user wishes. It comprises of 5 information's on the right. These information's can show parameters of the system, or parameters being sent into the system from other equipment.

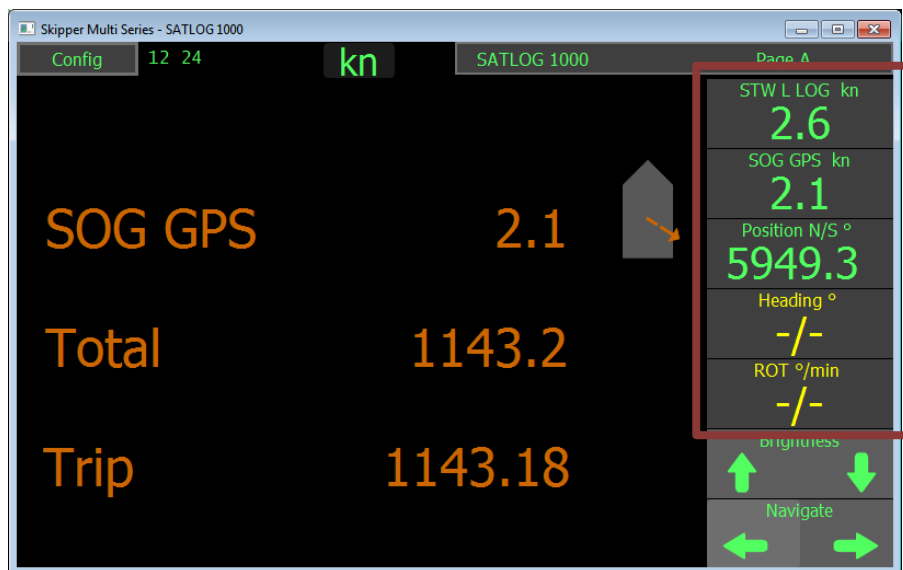

All these parameters are selected by default, but can be changed to show whatever the user chooses. See the User guide 'Changing the look of the screen' Runtime screen setup

### Display setup

The Display setup menu gives access to the system parameters the dimming set up and the Network parameters.

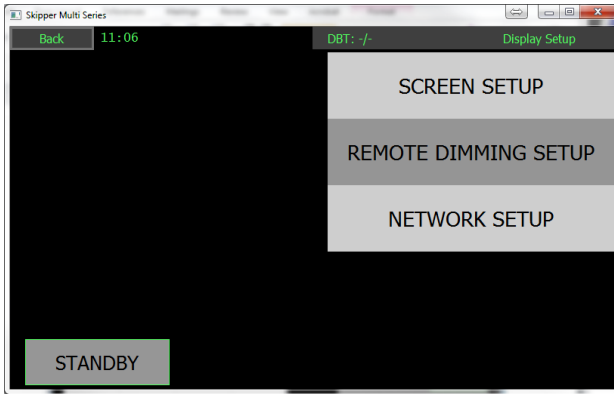

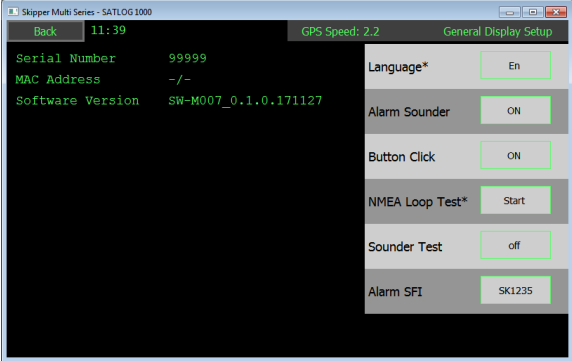
General Display setup	
 <p>Software version can be updated via Service software Serial number of this product Hardware and firmware version and serial number of the JB70SD21-SA transceiver unit</p>	Only English currently available
	Button click, sound feedback on touching the screen
	Alarm sounder, on / Off (Fixed on in ALF mode)
	NMEA loop test. Self test on this screens inputs and outputs
	Sounder test: This will beep at full volume

This screen sets up the hardware parameters of the control unit.

### Dimming setup

The Dimming levels can be set up on this screen. The user can select dimming and color choices for the 4 preset levels that can be sent remotely (using DDC NMEA command). When the user uses the on screen dimming, the color scheme will change when the dimming level passes the set % value and the user releases the slider.

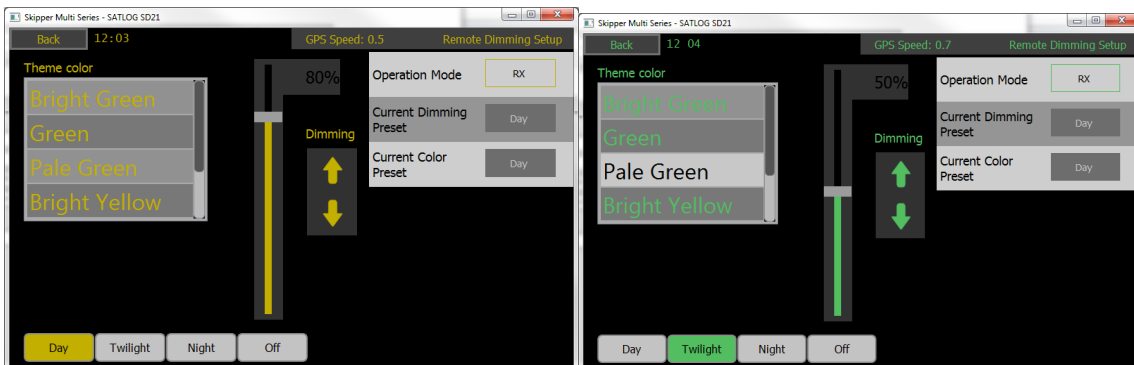

## Network setup

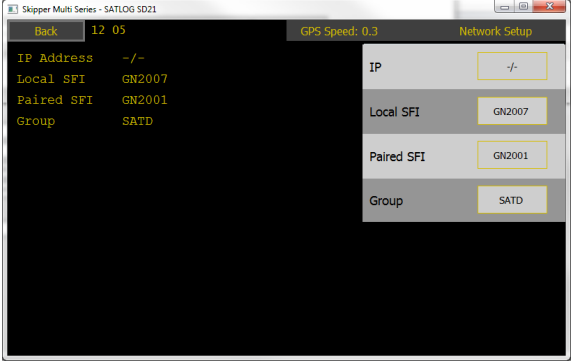
	<p>Description</p>
<p>function</p>	
<p>IP</p>	<p>The IP address of the display can be changed here, this should normally be within the range of 172.16.1.1-254 (Default 172.16.1.106)</p>
<p>Local SFI</p>	<p>The function identifier for this system Default GP2002</p>
<p>Paired SFI</p>	<p>The name of the JB unit this system is connected to. Default GP2001</p>
<p><b>System Name</b></p>	<p><b>The name of the system presented when searched for</b></p>
<p>Group</p>	<p>The group of systems within the network protocol. Normally SATD or NAVD</p>

## System Setup

The Speed log will give transversal speeds at the bow and the stern. To ensure these are correct the distances from the antenna to the bow and stern must be given.

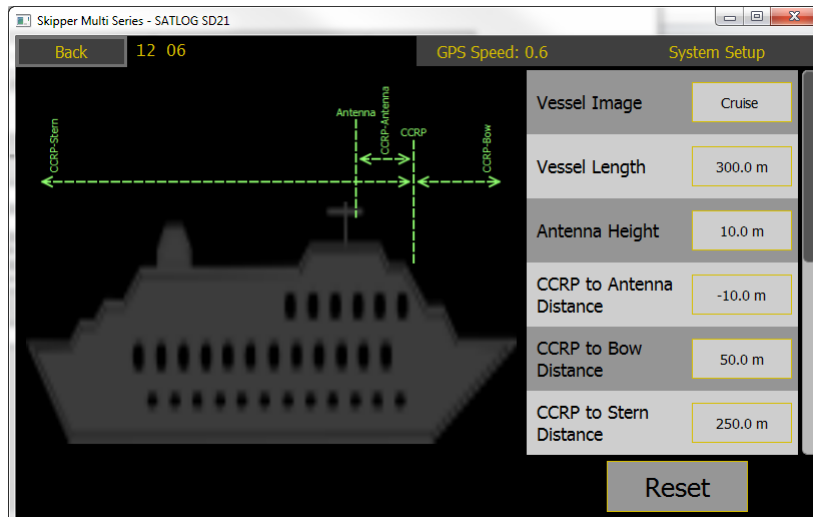

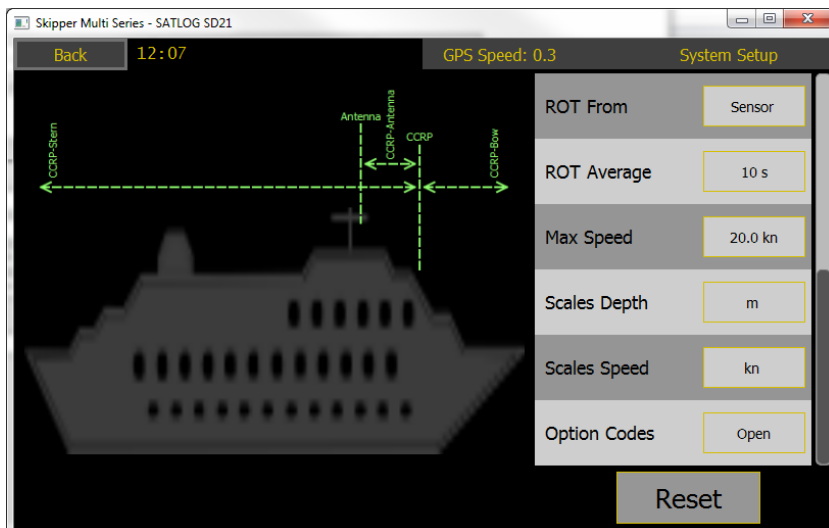

Parameter	Description
Vessel image	Type of vessel
Vessel Length	Legth from bow to stern
Antenna height	Height above normal sea level
CCRPs to antenna distance	Alongships distance to the antenna centre
CCRPs to Bow distance	Distance from the steering position to the bow
CCRPs to stern	Distance from steering position to the stern
ROT From	Source of Rate of turn, from internal accelerometer or GPS HDT
ROT Average	Averaging used on the ROT inputs
Scales Depth	Units used for depth m , ft, fathems
Scales speed	Units used for speed (kn, m/s, mi.h)

### JB70 Setup

This screen sets up the parameters of the JB70 unit, and ensures the screen and JB70 unit are correctly matched (paired)



function	Description
----------	-------------

IP	The IP address of the display can be changed here, this should normally be within the range of 172.16.1.1-254 (Default 172.16.1.106)
Local SFI	The function identifier for this system Default GP2001
System Name	The name of the system presented when searched for
Group	The group of systems within the network protocol. Normally SATD or NAVD. Other groups MISC, TIME, TGTD, VDRD, PROP, RCOM are available

### Aux setup

The JB70 has a Plug J2 with digital outputs. This can be used to provide Pulses per NM, or other control signals.

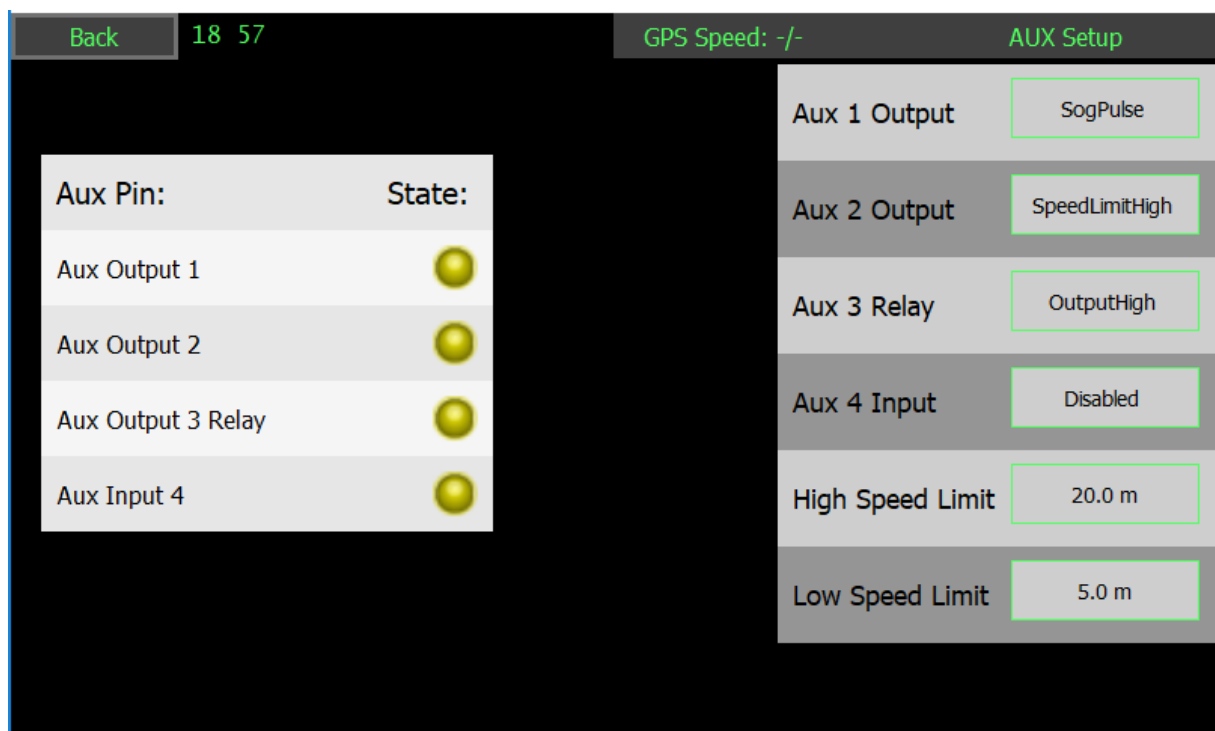

The panel on the left shows the status of the output. The selected output is shown on the right.

function	Description
SOG Pulse output	
Speed Limit(Hi, Lo)	Changes the state of the output to hi or lo / lo or high, between the speeds set on High speed limit and low speed limit.
Power failure	Changes state when power is not available to the JB70 unit
Output high / output low	Allows the user to set the level of the output



## Diagnostics

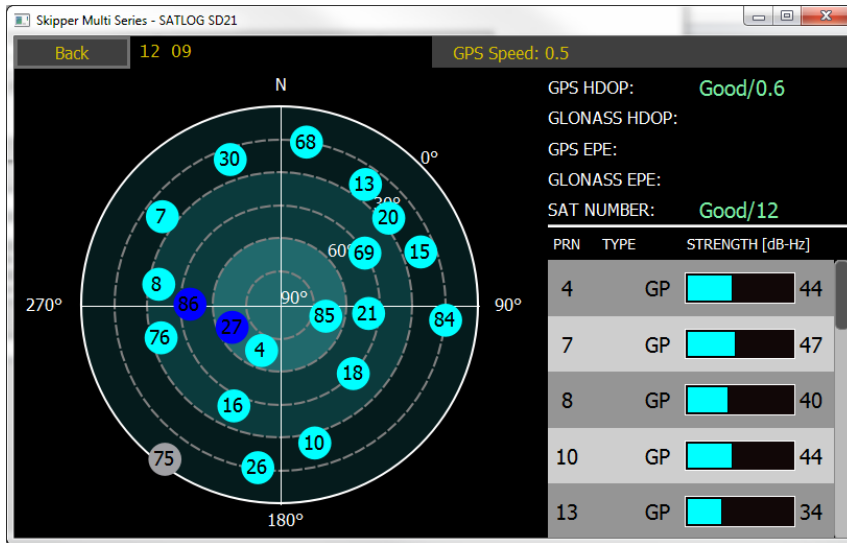

The diagnostics screen shows that the antenna is connected to adequate satellite's, the status of these is given on the right, and this summarized status can also be set up in the information's on the runtime screens.

## USER Information

### Introduction

The SD21 is a Speed over ground speed log based on GPS and GLONASS positioning systems, and an independent single axis DL1 Speed Through Water system. It is totally self contained and does not require inputs from other systems. The antennae module uses two GPS systems to find position, speed and heading. These combined give the required speed accuracy and direction.

The Screen can be setup to show the parameters that the user wishes to see or control, however there is no need for any adjustments or calibration after initial installation.

### Presentation

The user can select one of 3 presentations



### Selectable Information

All the buttons on the side can be selected.

### Screen Configuration

The main screen can be set up to show numerous informations on the right and below the screen

Buttons on the information and bottom bar can be adjusted to show the information the user required in the runtime setup.

Press and hold the button to see all the choices.

Press on the config button and runtime setup to access the general screen information options

All button functions are available in the menus, so if a button is selected away, it can be accessed from the config menus.

Main adjustable features are:

GPS position	The Longitude and latitude position of the vessel
Heading	A compass (True) heading
ROT(sens)	Rate of turn from the internal accelerometer of the system
ROT(comp)	Rate of turn, calculated from heading values from the antennae
Trip	The distance over ground sailed since last reset, can be reset by long press or remote signal.
Total	The total distance travelled over ground since installation,
Dimming	Dimming up and down is available using the up and down arrows, or the slider that pops up when a dimming arrow is touched. IF the system is dimmed too far down, press and hold the screen, and it will return to a 'visible level'. The screen will not dim fully down if an alarm is active. If an alarm becomes active when fully dimmed, the screen will return to the 'visible level'. And return after acknowledgement <i>This is always available, but can be adjusted in Display setup</i>
Resultant SOG	The resultant Speed Over Ground
Speed through water longitudinal STWL	<i>If a SKIPPER DL1, DL2, DL21, DL850, EML224 are connected to the system via NMEA or LAN, the system can display both speeds, and also calculate water current based on the the SOG and STW values</i>
STWT	<i>Transversal speed through water from an inputted signal</i>

All adjustments are available from the menus by pressing **Config**

## Changing the look of the screen

Go to Runtime Menu by pressing config in the top left. In this menu you will see the available Pages, and these can be individually tailored to show the information the user wishes.

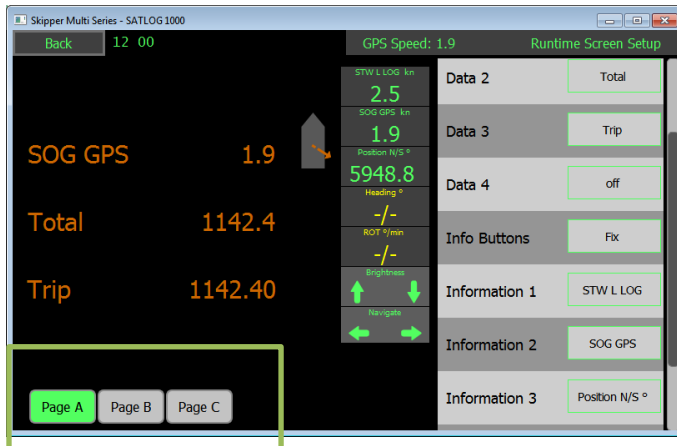

Button	Description
Page A Resultant Values	Presentation of speed with an icon for direction
Page B Vector values	Presentation of speeds with arrows
Page C Docking values	Presentation of the ship with forward and aft sideways speed and along ships
Info buttons	The information on the right can be made fixed or to disappear after a time
Information 1-5	Select the information/parameters to be shown on each information.

## Errors

If the system has a problem it can be:

- Antenna is not fully operational. Clock will not work, there will be no speed data (-.-)
- Antenna is not synchronized. Clock and SOG GPS work, but not Heading ROT or directional speed
- Antenna is not operational , Error shown on screen

To be updated , with optional mounting kit

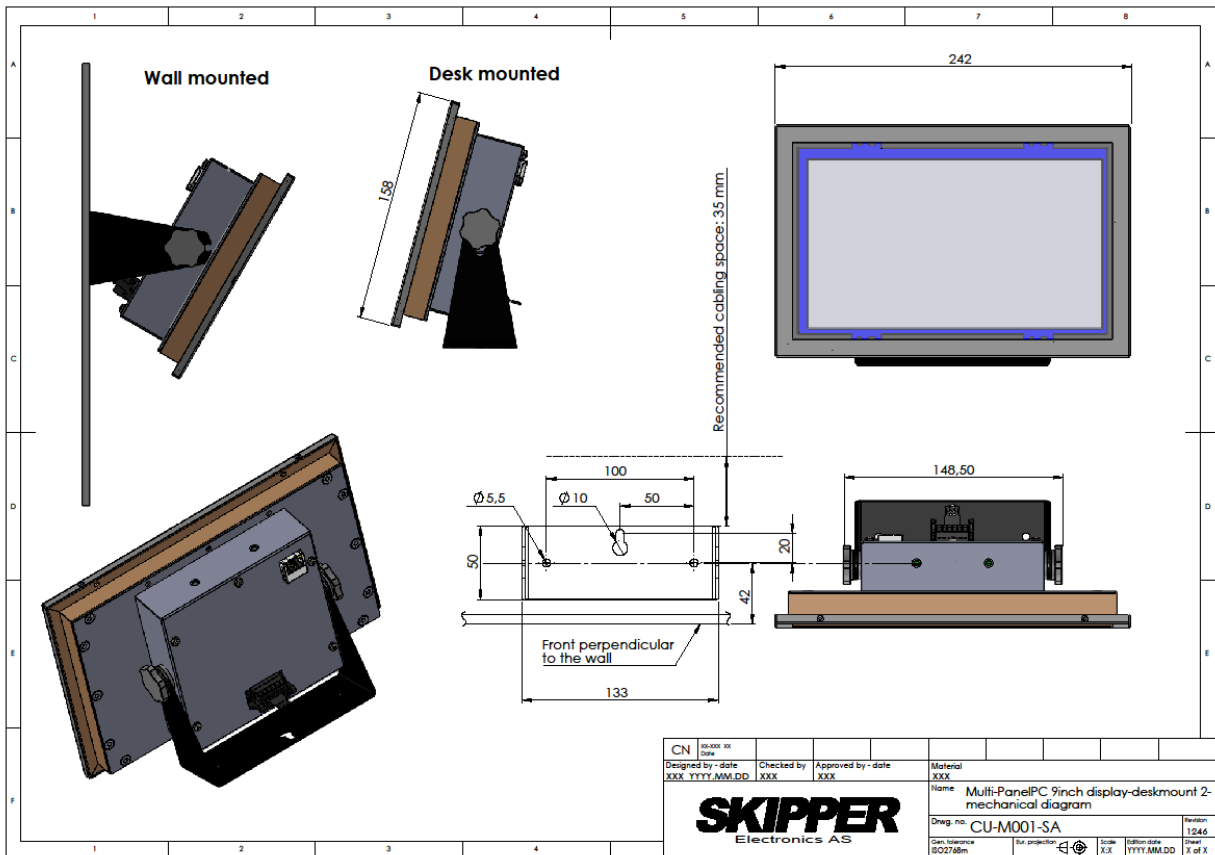

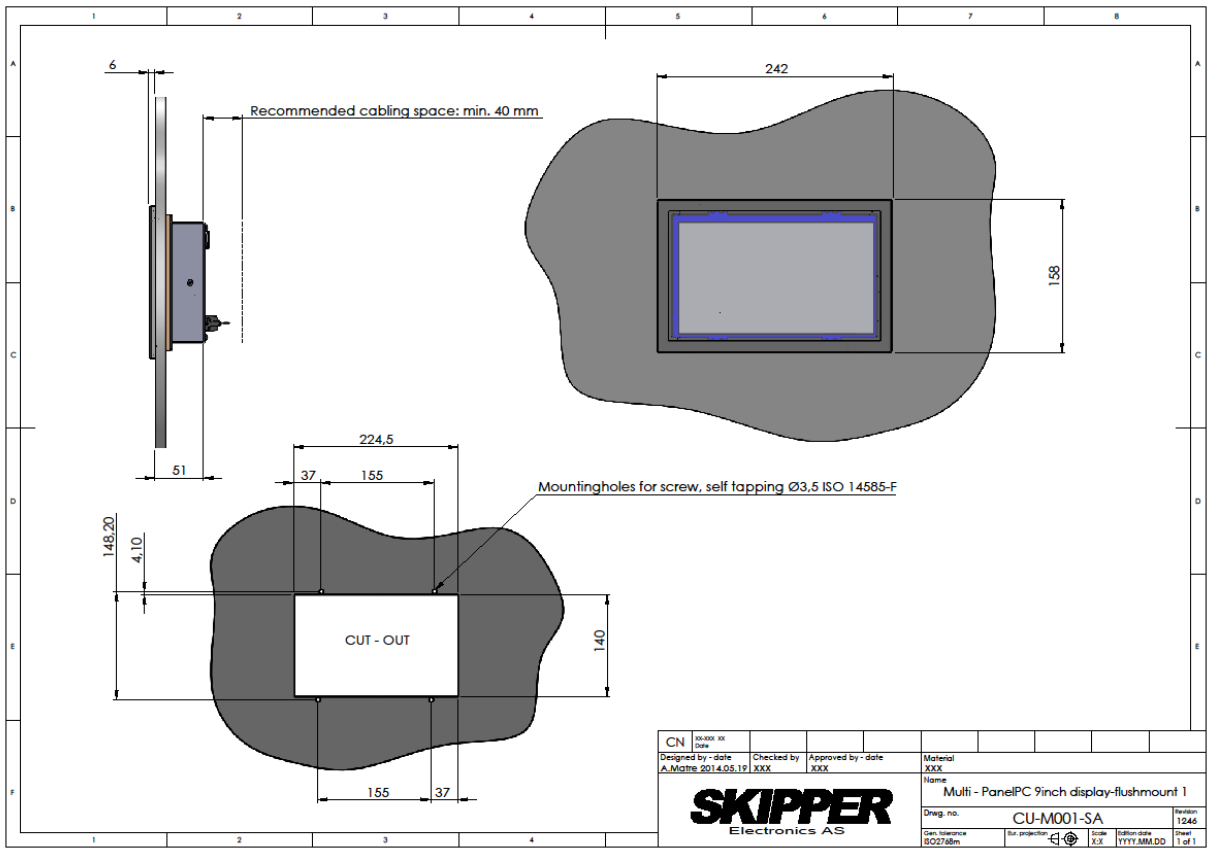

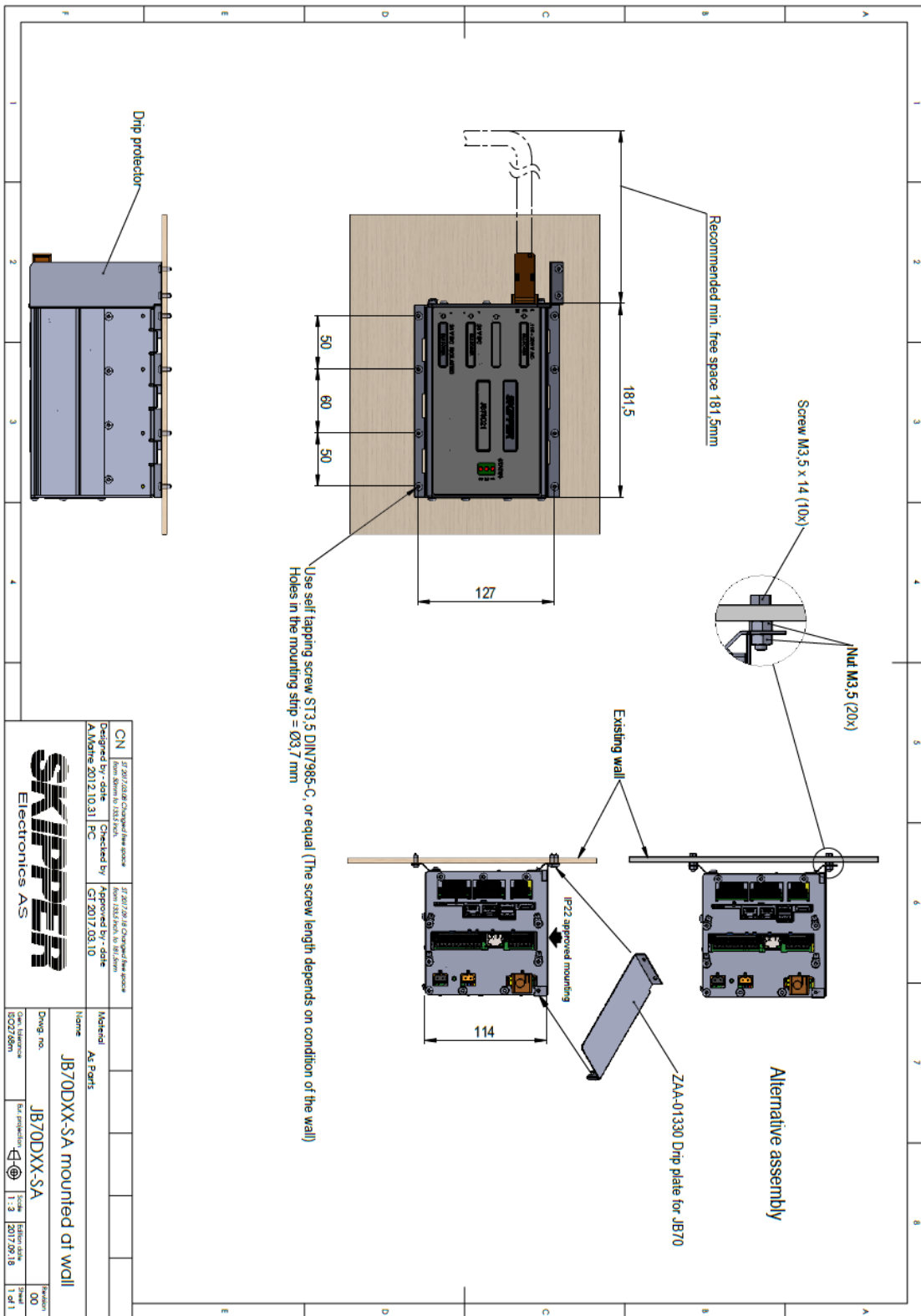

CN	27.2017.2028 Changed free space from 181.5 to 181.5 mm	27.2017.2003 Changed free space from 181.5 to 181.5 mm
Designed by - code	Checked by	Approved by - code
A. Malmgren 2017.10.31 HC	SI 2017.03.10	SI 2017.03.10
<p><b>SKIPPER</b> Electronics AS</p>		
Name	Material	AS Parts
JB70DX-SA mounted at wall		
Dwg no.	JB70DX-SA	
Client reference	8022766m	
Scale	1:1	Scale
1807.09.18		1807.09.18
Revision	00	Revision
1 of 1		1 of 1